

MONOLITHIC DELAY LINE CASE DIMENSIONS/ MECHANICAL DRAWINGS

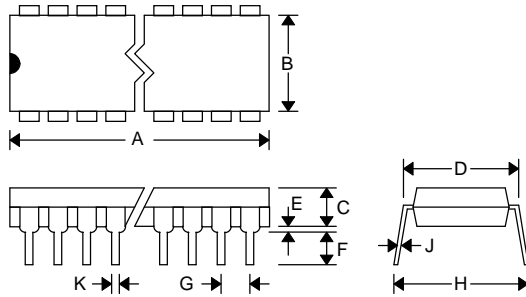

8-, 14- & 16-PIN DIP



PKG:	8-PIN (M)		14-PIN		16-PIN	
DIM	MIN	MAX	MIN	MAX	MIN	MAX
A IN.	0.360	0.400	0.740	0.780	0.740	0.780
MM	9.14	10.16	18.80	19.81	18.80	19.81
B IN.	0.240	0.260	0.240	0.260	0.240	0.260
MM	6.10	6.60	6.10	6.60	6.10	6.60
C IN.	0.120	0.140	0.120	0.140	0.120	0.140
MM	3.05	3.56	3.05	3.56	3.05	3.56
D IN.	0.300	0.325	0.300	0.325	0.300	0.325
MM	7.62	8.26	7.62	8.26	7.62	8.26
E IN.	0.015	0.040	0.015	0.040	0.015	0.040
MM	0.38	1.02	0.38	1.02	0.38	1.02
F IN.	0.120	0.140	0.120	0.140	0.120	0.140
MM	3.04	3.56	3.04	3.56	3.04	3.56
G IN.	0.090	0.110	0.090	0.110	0.090	0.110
MM	2.29	2.79	2.29	2.79	2.29	2.79
H IN.	0.320	0.370	0.320	0.370	0.320	0.370
MM	8.13	9.40	8.13	9.40	8.13	9.40
J IN.	0.008	0.012	0.008	0.012	0.008	0.012
MM	0.20	0.30	0.20	0.30	0.20	0.30
K IN.	0.015	0.021	0.015	0.021	0.015	0.021
MM	0.38	0.53	0.38	0.53	0.38	0.53

8-, 14- & 16-PIN GULL-WING

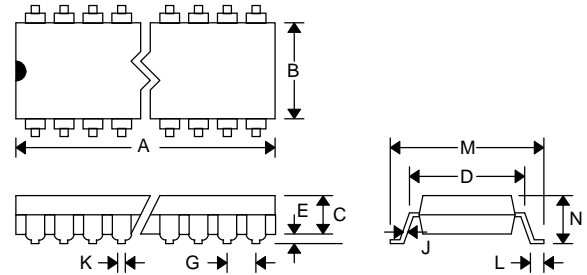

PKG:	8-PIN (H)		14-PIN (G)		16-PIN (G)	
DIM	MIN	MAX	MIN	MAX	MIN	MAX
A IN.	0.345	0.400	0.740	0.780	0.740	0.780
MM	8.76	10.16	18.80	19.81	18.80	19.81
B IN.	0.240	0.260	0.240	0.260	0.240	0.260
MM	6.10	6.60	6.10	6.60	6.10	6.60
C IN.	0.120	0.140	0.120	0.140	0.120	0.140
MM	3.05	3.56	3.05	3.56	3.05	3.56
D IN.	0.300	0.325	0.300	0.325	0.300	0.325
MM	7.62	8.26	7.62	8.26	7.62	8.26
E IN.	0.020	0.050	0.020	0.050	0.020	0.050
MM	0.51	1.03	0.51	1.03	0.51	1.03
G IN.	0.090	0.110	0.090	0.110	0.090	0.110
MM	2.29	2.79	2.29	2.79	2.29	2.79
J IN.	0.008	0.012	0.008	0.012	0.008	0.012
MM	0.20	0.30	0.20	0.30	0.20	0.30
K IN.	0.015	0.021	0.015	0.021	0.015	0.021
MM	0.38	0.53	0.38	0.53	0.38	0.53
L IN.	0.030	0.050	0.030	0.050	0.030	0.050
MM	0.76	1.27	0.76	1.27	0.76	1.27
M IN.	0.370	0.430	0.370	0.430	0.370	0.430
MM	9.40	10.92	9.40	10.92	9.40	10.92
N IN.	0.160	0.180	0.160	0.180	0.160	0.180
MM	4.06	4.57	4.06	4.57	4.06	4.57

8, 14 & 16 PIN SOIC 16 & 20 PIN SOW

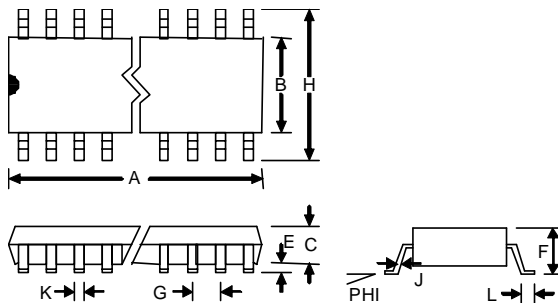

PKG:	8-PIN (Z)		14-PIN (D)		16-PIN (R)		16-PIN (S)		20-PIN (W)	
DIM	MIN	MAX	MIN	MAX	MIN	MAX	MIN	MAX	MIN	MAX
A IN.	0.188	0.196	0.337	0.348	0.387	0.398	0.402	0.412	0.502	0.512
MM	4.78	4.98	8.55	8.84	9.83	10.11	10.21	10.46	12.75	13.00
B IN.	0.150	0.158	0.150	0.157	0.150	0.157	0.290	0.300	0.290	0.300
MM	3.81	4.01	3.80	4.00	3.80	4.00	7.37	7.65	7.37	7.65
C IN.	0.052	0.062	0.052	0.062	0.052	0.062	0.089	0.095	0.089	0.095
MM	1.32	1.57	1.32	1.57	1.32	1.57	2.26	2.41	2.26	2.41
E IN.	0.004	0.010	0.004	0.010	0.004	0.010	0.004	0.012	0.004	0.012
MM	0.10	0.25	0.10	0.25	0.10	0.25	0.10	0.30	0.10	0.30
F IN.	0.058	0.068	0.058	0.069	0.058	0.069	0.094	0.105	0.094	0.105
MM	1.47	1.73	1.47	1.75	1.47	1.75	2.38	2.68	2.38	2.68
G IN.	0.050 BSC 1.27 BSC		0.050 BSC 1.27 BSC		0.050 BSC 1.27 BSC		0.050 BSC 1.27 BSC		0.050 BSC 1.27 BSC	
H IN.	0.230	0.244	0.228	0.244	0.228	0.244	0.398	0.419	0.398	0.419
MM	5.84	6.20	5.80	6.20	5.80	6.20	10.11	10.65	10.11	10.65
J IN.	0.007	0.010	0.007	0.010	0.007	0.010	0.009	0.013	0.009	0.013
MM	0.19	0.25	0.19	0.25	0.19	0.25	0.23	0.33	0.23	0.33
K IN.	0.013	0.019	0.013	0.019	0.013	0.019	0.013	0.019	0.013	0.019
MM	0.33	0.49	0.33	0.49	0.33	0.49	0.33	0.49	0.33	0.49
L IN.	0.016	0.035	0.027	0.035	0.027	0.035	0.016	0.040	0.016	0.040
MM	0.40	0.89	0.69	0.89	0.69	0.89	0.40	1.02	0.40	1.02
PHI	0 DEG	8 DEG	0 DEG	8 DEG	0 DEG	8 DEG	0 DEG	8 DEG	0 DEG	8 DEG